

# A Model-based Dynamic Toll Pricing Strategy for Controlling Highway Traffic

Thao Phan, Anuradha M. Annaswamy, Diana Yanakiev, and Eric Tseng

**Abstract**—A model-based approach to dynamic toll pricing has been developed to provide a systematic method for determining optimal freeway pricing schemes. A novel approach is suggested for alleviating congestion, which utilizes identified models of driver behavior and traffic flow, as well as optimization of the target density to maximize throughput. Real-time traffic information from on-road sensors is integrated with historical information to provide feedback and preview for the dynamic toll price controller. The algorithm developed here provides an opportunity to improve on existing toll policy by guaranteeing minimum speeds for toll lane drivers, maintaining consistent traffic flow for the other drivers, and optimizing the overall traffic throughput.

## I. INTRODUCTION

WITH the growth and expansion of many large metropolitan centers in the last few decades, the problem of traffic congestion continues to grow and vex commuters, commercial drivers, city planners and officials, and environmentalists worldwide. The introduction of the automobile in the early 20th century was, indeed, a great innovation, but for some areas, the overwhelming number of cars on the road today results in daily traffic jams and perpetually stressed drivers. Over 1 billion vehicles travel on the roads today, and that number is projected to double by 2050 [1]. Investing in public transportation infrastructure would go far to reduce that number; however, such an effort generally requires years of planning, significant funds, and an underlying city geography that is conducive to public transit. Unfortunately, driving a car is an unavoidable choice for at least 65% of city populations, who rely on their vehicles to get to school or work [2].

For those commuters who are forced to drive through rush hours daily, the lost time can be a significant cost. For example, traveling in New York City takes 50-75% longer during peak hours, and translated into a monetary cost, traffic congestion in NYC causes a loss of \$8 billion a year. As reported in [3], the number of hours spent in traffic jams over a 5 day period, for the cities in France, Honolulu, San Francisco, and Los Angeles are 35, 56, 60, and 64, respectively. For an individual driver, each hour in traffic costs about \$21 [3]. In addition to these time-related costs, the mental cost of driving in traffic is not insignificant. A global study by IBM indicated that

55% of those surveyed incurred 30-60 minutes of delay due to traffic jams, with 42% reporting increased stress levels [2]. That survey also indicated that 41% believe the issue of traffic is worsening, despite the efforts of transportation officials and city planners.

New approaches and solutions are required to solve, or at least alleviate, the problem of traffic congestion. Within the last few years, intelligent transportation systems have been increasingly introduced and implemented in the US. For example, real-time traffic information from cellphone signals is being used by Google Maps to give consumers travel time predictions and suggested routes. Dashboards and smartphone applications like Waze now have the capability of providing estimates of the current state of traffic. Through the works of local transportation departments, posted signs on highways also offer estimated travel times. For decades, toll pricing has been utilized as a form of congestion pricing, and within the last decade, a new form of toll pricing, one which charges a dynamic toll based on real-time traffic conditions, has been employed to manage traffic congestion. The focus of this paper is a novel dynamic toll pricing scheme that alleviates congestion and maintains an optimized traffic density during peak hour traffic.

A dynamic toll pricing system bases toll prices on the real-time, measured road conditions while a static pricing system does not; the latter can consist of systems that have one set toll price or variable toll prices depending on the time of day. Dynamic toll pricing systems have gained popularity within the last decade, especially in the US. The earliest dynamic toll pricing system in the US originated in Minneapolis, MN [4], termed MnPASS, and many other cities have followed suit and also adopted dynamic toll pricing. These systems can be seen in Seattle, WA, Atlanta, GA, Los Angeles, CA, and Virginia [5]–[8]. The toll pricing strategy proposed in this paper is designed, analyzed, and evaluated using the MnPASS traffic data.

Since 2004, dynamic toll pricing has been implemented on I-394 and I-35 in Minneapolis, MN during the peak hours in the morning (6-10AM) and afternoon (3-7PM). To determine the price charged to users of the dynamic toll lane, denoted as the High Occupancy Toll (HOT) lane, the MnPASS system collects data regarding traffic speeds in real-time, using inductive loop detectors embedded into the roads. The MnPASS system, then, estimates the maximum density downstream of the user's entry point and charges a toll price (see Fig. 1). The HOT toll price changes every three minutes and the user is charged automatically through a transponder

This work was supported by the Ford-MIT Alliance.

Thao Phan and Anuradha M. Annaswamy are with the Department of Mechanical Engineering, Massachusetts Institute of Technology, Cambridge, MA 02139, USA. {tkphan,aanna}@mit.edu

Diana Yanakiev and Eric Tseng are with Research and Advanced Engineering, Ford Motor Company, Dearborn, MI 48121, USA. {dyanakie,htseng}@ford.com

Level of Service	Min K	Max K	Min Rate (\$)	Default Rate (\$)	Max Rate (\$)
A	0	11	0.25	0.25	0.50
B	12	18	0.50	0.50	1.50
C	19	31	1.50	1.50	2.50
D	32	42	2.50	3.00	3.50
E	43	49	3.50	5.00	5.00
F	50	50	5.00	8.00	8.00

Density in veh/mi/ln; Prices in \$

Density	$\Delta 1$	$\Delta 2$	$\Delta 3$	$\Delta 4$	$\Delta 5$	$\Delta 6$
0-18	\$0.25	\$0.25	\$0.25	\$0.25	\$0.25	\$0.25
19+	\$0.25	\$0.50	\$0.75	\$1.00	\$1.25	\$1.50

Fig. 1. The current pricing plan for MnPASS.

that is leased from the MnDOT [4].

In this article, a novel approach is utilized for determining the dynamic toll prices. Viewing the real-time traffic information data as a sensor, and the price based on this data as a control input, the underlying traffic congestion problem is posed as a control problem. This control input is then presented to a driver who can be viewed as an actuator - by virtue of his or her decision to enter the HOT lane, the driver affects the traffic flow. This, in turn, implies that the problem that remains is to determine the underlying model which is a combination of a traffic flow model and a behavioral model of the driver. The approach that is proposed in this paper is the design of a real-time control strategy for toll prices based on a socio-technical model that combines traffic flow dynamics with behavioral dynamics of a driver.

A low-order lumped parameter model of a single lane traffic is used to capture the traffic flow dynamics and an algebraic nonlinearity based on the logistic function [9] is used to capture the behavioral model. The combined socio-technical model is parameterized and validated using the MnPASS traffic data and the MnPASS pricing strategy. Our model-based toll price is then evaluated using MnPASS traffic flow data, in terms of its ability to divert traffic flows from a fixed toll lane to the HOT lane and in terms of the overall traffic flow and traffic speeds. As is demonstrated in the sections that follow, significant advantages result from the proposed pricing algorithm. Moreover, the model-based approach not only provides analytical guarantees but is also applicable to a wide range of traffic problems where a sensor network is prevalent, to provide different levels of congestion alleviation, revenue generation, and flow optimization, based on the policy-maker's desired objectives.

Studies on pricing for congestion control have been examined in [11], [13] and references therein. These studies can be categorized into two groups: analysis of time-varying pricing based on classical economic theory where the toll price is set to balance marginal social costs with marginal driver costs, but assumes traffic flows to consist of point masses, and those that

employ a spatial traffic-model, which employs first-principle based on the classical traffic model in [10]. The latter is similar in structure to that proposed here but differ from our approach in the determination of the control parameters, as well as its overall analysis, which is empirical in nature. The research conducted here, in contrast, maximizes overall traffic flow and HOT speeds because of our analytical, model-based analysis.

In addition to the above, ref. [12] has addressed the specific problem of dynamic toll pricing in Minneapolis [12]. Coordinating with MnPASS policy-makers, they have tested different toll pricing schemes to better model driver elasticity and decision-making. Their approach to toll pricing differs by offering a discrete table of prices as their pricing controller, and is, again, more empirical than our analytical method. The research they have conducted, however, is important in providing us information to base our system model upon.

Details on the model of the proposed intelligent transportation system are shown in Sections II and III. Parameterization results are shown in Section IV, and simulation results are detailed in Section V. Section VI closes with overall conclusions and future work for this project.

## II. A SOCIO-TECHNICAL TRAFFIC FLOW MODEL

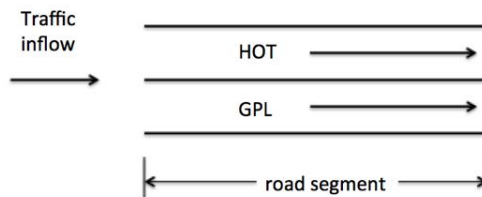

Fig. 2. A physical schematic of the road segment. The HOT lane is in parallel with the GPL. No traffic flows between the two beyond are assumed to occur the initial entry point.

The underlying traffic structure is assumed to consist of a HOT lane and a GPL in parallel (see Fig. 2). This entire road section will be referred to as a road segment throughout the paper. A critical assumption is that there are no lane changes between the HOT and GPL lanes for the segment considered. The goal is to determine a suitable dynamic toll pricing strategy that ensures an increase in the overall traffic flow in the combined HOT and GPL lanes and traffic speeds close to the speed limit in the HOT lane.

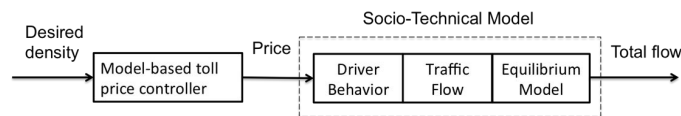

Fig. 3. A higher-level block diagram for our dynamic pricing system. The price influences the number of drivers that go into each lane, which is determined by the driver behavior model. The number of vehicles, then, affect the lane densities, closing the loop.

The procedure that we adopt to determine the overall controller begins with a desired density in the HOT lane. Any departure of the actual density from this value is fed into our price controller, which is the main component of our proposed approach. The resulting output, i.e. the toll price of the HOT lane, enters as an input into the socio-technical model. The latter in turn consists of both the driver behavior model, which represents the driver's decision of whether or not to enter the HOT lane, and the traffic flow model that captures the dynamics between the incoming traffic density and outgoing traffic density of the underlying road segment. In what follows, we describe each of the components in this overall feedback loop, shown in Fig. 3.

#### A. Traffic Flow Model

Incorporating a model for traffic flow is crucial in understanding the underlying dynamics and developing a pricing scheme to prevent the onset of congestion. A kinematic model using a particle-flow analogy, denoted as the Lighthill-Whitham-Richards (LWR) model [10], [13] is often used to describe traffic flow. As our focus is on the dynamics when the traffic is close to congestion where the traffic is in an unsteady state, we do not use the LWR model or its simplifications which, for the most part, focuses on steady characteristics of traffic flow. Instead, we use an accumulator model that is an aggregate, lumped-parameter model that captures the most dominant dynamics. This model is first order, whose time constant,  $\tau$ , depends on the average speed,  $\bar{v}$ , of the traffic stream. Qualitatively,  $\tau$  represents the time it takes a car to traverse a road segment of length  $L$ .

$$\frac{q_{out,HOT}(s)}{q_{in,HOT}(s)} = \frac{1}{\tau s + 1} \quad (1)$$

where  $\tau = L/\bar{v}$ .

The average density,  $\rho$  is determined based on the current inflow (derived from real-time sensor measurements) with the following equation,

$$\rho = \frac{\int_0^T q_{in}(t) - q_{out}(t) dt}{L} \quad (2)$$

With these, we can derive the underlying transfer function for the HOT lane as

$$\frac{\rho(s)}{q_{in}(s)} = \frac{\tau}{\tau s + 1} \quad (3)$$

A similar traffic model was assumed for the fixed toll lane as well.

In contrast to the MnPASS model, which evaluates local densities, our system calculates the average density,  $\rho$ , of the road between two sensors by tracking the vehicles that enter,  $q_{in}(t)$ , and exit,  $q_{out}(t)$ , the road segment. The number of cars that lie in the road segment is known based on the volume measurements from the loop detectors, and the length of the segment is a fixed value; therefore,  $\rho$  is known based on existing data, barring an offset of the initial number of

cars in the segment. This accumulator method gives a better estimation of the road conditions inside the segment than the MnPASS system, where only local densities over the length of the field sensor are being measured.

#### B. Equilibrium Model

The price controller that we propose in this paper employs a reference density; the rationale behind this is that density is a direct metric of congestion and in addition provides a convenient tool for optimizing the proposed algorithm. The traffic flow model provides the output density from the input flow, but furthermore, we need to determine the lane velocities in real time. The relation between traffic density and speed for various traffic conditions is nonlinear and complex [10] and has been studied at length in the transportation literature. While in general, velocity decreases with density, the underlying gradient changes drastically depending on whether or not the density exceeds a critical threshold (see Fig. 4). Using this feature, we propose a simplified equilibrium model as [10]

$$\bar{v}(\rho) = \begin{cases} v_{free-flow} & \rho < \rho_{critical} \\ a\rho + b & \rho_{critical} \leq \rho \leq \rho_{critical} \\ v_{jam} & \rho > \rho_{jam} \end{cases} \quad (4)$$

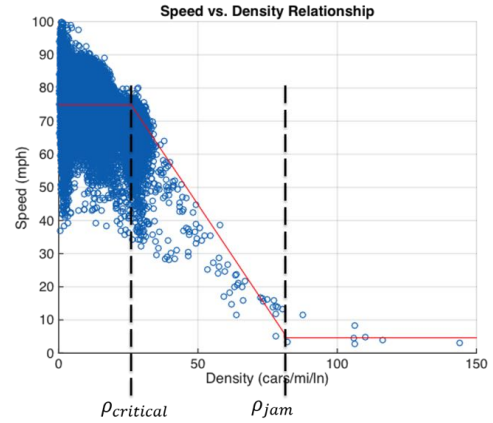

Fig. 4. The equilibrium relationship between speed and density.

Density and speed information from MnPASS for the year 2014 was collected and averaged over a five minute period to obtain the equilibrium data used in Fig. 4.

#### C. Driver Behavior Model

Modeling driver behavior is vital in developing an effective pricing scheme. Since the goal of this system is to direct vehicles to desired roads in certain quantities, understanding and quantifying the motivations of drivers is important for the solution.

Each individual driver entering the road segment has a choice of entering the HOT or the GPL lane. The choice is essentially based on the lane that offers a higher utility  $U$ , and can be captured in a commonly used logistic model [17]. We

choose the utility function to be a linear combination of the travel time  $T$  and toll price  $P$ , as

$$U = -\alpha T - \beta P + \gamma \quad (5)$$

where  $\alpha$  and  $\beta$  represent the weighting of travel time and price, respectively, and  $\gamma$  is an offset term used to represent other unobservables. As the goal is to minimize  $T$  and  $P$ , the negative signs in (5) allow the problem to be cast as the maximization of  $U$ .

The marginal utility  $\Delta U$  of choosing the HOT lane vs. GPL lane can therefore be represented as

$$\Delta U = \alpha \Delta T - \beta P_{HOT} + \gamma \quad (6)$$

where  $\Delta T$  represents the time savings of travel in the HOT over the GPL lane, and  $P_{HOT}$  denotes the price of the HOT lane (assuming that the fixed toll lane has zero tolls). The time savings  $\Delta T$  is determined by road segment length and the speed of the two lanes at the entry point. The assumption is that the drivers make an estimate of the road speeds and a corresponding  $\Delta T$ .

It should be noted that the driver behavior model in (5) and (6) naturally extends to a macroscopic scale. The driver's discrete choice to choose the HOT lane, when extended to model a population of drivers, becomes a logistic function that describes the fraction of drivers that take the HOT lane,  $\frac{q_{HOT}}{q_{in}}$ . The aggregate driver behavior model is summarized below, and a visual of the logistic model is displayed in Fig. 5. The input from the driver behavior model then changes the input flow as

$$q_{in,HOT} = f(\Delta T, P_{HOT}) * q_{in} \quad (7)$$

where

$$f(\Delta T, P_{HOT}) = \frac{1}{1 + e^{\alpha \Delta T - \beta P_{HOT} + \gamma}} \quad (8)$$

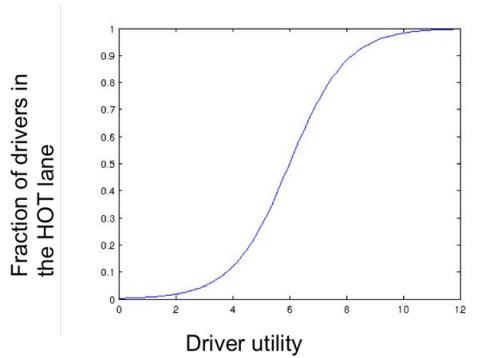

Fig. 5. The logistic model used to characterize driver behavior and determine the HOT usage. The input to the model is the driver utility, which is a weighted sum of the current toll price and perceived time savings.

### III. MODEL-BASED PRICE CONTROL STRATEGY

With the overall socio-technical model determined as in Section II, we now describe the model-based control strategy for the toll price in this section, the details of which are illustrated in Fig. 6. This controller consists of two parts, a linear dynamic component, and a nonlinear algebraic component. The former is a PD-controller, while the second is a logit function that serves as an inverse of the driver behavior model. In addition to these two parts, a feedforward component is added to the controller to ensure control authority. These are described in greater detail below.

#### A. PD Controller

A PD controller is used to track the desired density relatively quickly and to prevent large increases in the HOT density:

$$u = K_p e + K_d \dot{e} \quad (9)$$

where the error  $e = \rho_{ref} - \rho$ , and  $K_p$  and  $K_d$  denote the proportional and derivative gains, respectively. The derivative component reacts to changes in the system's density, thereby mitigating deviation from the traffic equilibrium model mentioned above. Moreover, the derivative (lead) term compensates the lag dynamics of the accumulator model of the road segment.

#### B. Feed Forward Component

A feed forward component was added to the PD controller to provide greater control authority. Because the inverse driver behavior function is relatively flat near the lowest values of driver utility, a feed forward gain,  $K_{ff} = a$  was added to ensure equilibrium when  $\rho = \rho_{ref}$ . The input,  $y$ , to the inverse driver behavior model is given by

$$y = K_p e + K_d \dot{e} + K_{ff} \rho_{ref}. \quad (10)$$

#### C. Inverse Driver Behavior

The purpose of the inverse driver behavior function is to compensate for the nonlinear behavior of the driver modeled as in section II-C. Ideally, this inverse function would yield a perfect cancellation with the driver behavior logistic function and reduce the system to a first order system with a variable time constant. This inverse function has two inputs: the total incoming flow,  $q_{in}$ , and  $y$ , which actually is the desired flow into the HOT lane, and an output  $P_{HOT}$ , and is given by

$$P_{HOT} = \frac{1}{\beta} [\alpha \Delta T + \gamma - \ln(\frac{q_{in}}{y} - 1)] \quad (11)$$

### IV. DETERMINATION OF PARAMETERS

With the socio-technical model as in Section II and the Price Controller as in Sections III, we address the selection of the controller parameters  $K_d$ ,  $K_p$ , and  $K_{ff}$  in this section. These, in turn, will be determined on the basis of the model parameters  $L$ ,  $\alpha$ , and  $\beta$ . We use the MnPASS data to determine various parameters of the traffic flow model, as well as the

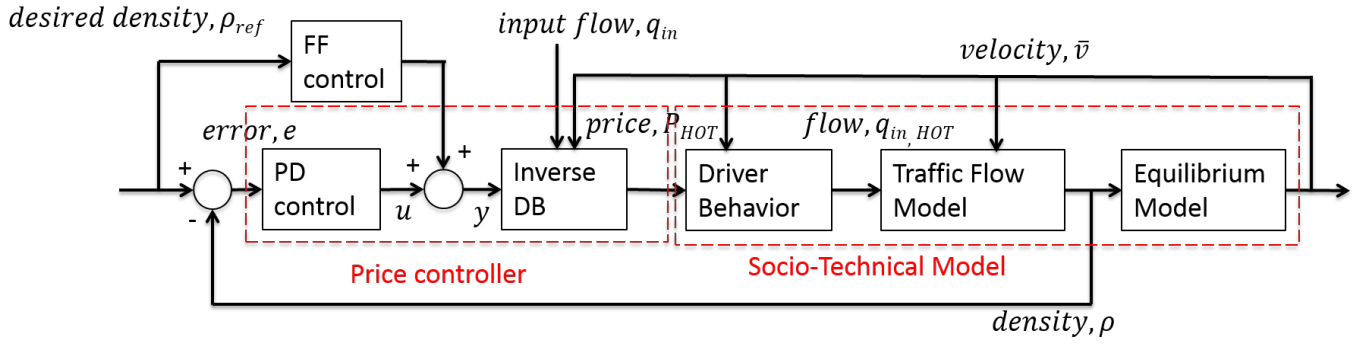

Fig. 6. The inputs, subsystems, and variables of the entire system are shown in this representative block diagram. The input into the system is the desired density in the HOT lane, and the output is the actual density. The input flow is the measured, total flow into the system.

driver behavior model in the following two sections. While the actual measurements can be used for feedback in the real, physical system, the two models need to be completely defined to create a realistic simulation environment.

### A. Traffic Flow Model Parameterization

In order to determine the traffic flow model, density and speed measurements were taken from the MnPASS system. A 0.7 mile road segment was chosen,  $L = 0.7$ , which in turn, gives us the value of the time delay,

$$\tau = \frac{0.7}{\bar{v}}. \quad (12)$$

The entry and exit points of this road segment are shown in Figure 7, marked as S77 and S37, respectively. Analysis of this road segment was ideal due to the lack of on- or off-ramps and the inability to switch between HOT and GPL lanes. Traffic data from November 2013 to January 2014 was collected using sensor measurements at S36 and averaged to determine the density-speed relationship to use in the model.

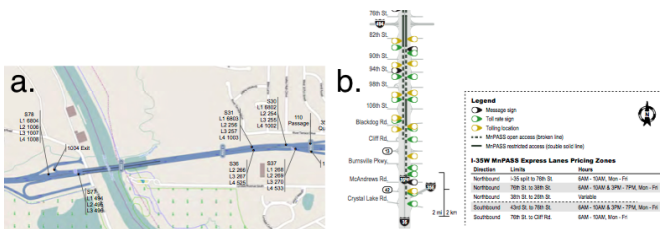

Fig. 7. The physical map of the road segment (7a) and the schematic (7b). The road segment chosen lies on I-35W. Black dots on 7a indicate sensor locations. Figure 7b reveals operational details concerning the location of toll collection, restricted entrances, and toll rate signs.

Another key operational point is that of carpool users. In most current implementations of dynamic toll pricing in the U.S., vehicles with two or more passengers are authorized to use the HOT lane at no cost. MnPASS allows carpool vehicles the use of the HOT lane for free, and this consideration was taken into account in both the parameterization of the data and the implementation of the simulation. With respect to the parameterization, a constant 55/45% split between carpool and

paying users was assumed in the toll lane. More exact information can be gathered by obtaining the specific transponder log data from MnDOT; however, since little variation in carpool users is seen day to day, a constant percentage was chosen for this study. The driver behavior model in (7) is therefore changed as

$$q_{HOT} = 0.45 * f(\Delta T, P_{HOT}) * q_{in} \quad (13)$$

### B. Driver Behavior Parameterization and Recursive Least Squares Estimation

In order to determine the fit of the logistic driver behavior model, volume and speed data was taken from 6am to 10am, Monday to Friday, between November 2013 and January 2014. Price data was obtained directly from MnPASS operators, and the driver volumes used were taken from station S77. As the patterns seemed to vary significantly from one weekday to the next, a set of parameters, one set for each day, was determined.

Using MATLAB's glmfit function, the coefficients for the driver utility model,  $\alpha$  and  $\beta$ , were determined. Table 1 summarizes the results of the model fitting with the standard deviations shown in parentheses. A value of travel time savings metric, VOT, can be calculated from the coefficient values as

$$VOT = \left| \frac{\beta}{\alpha} \right| \quad (14)$$

which represents the amount per minute of time savings that the overall population of drivers is willing to pay.

Comparison with recommended values by MnDOT (0.2667 \$/min) and USDOT (0.3817 \$/min) show that the values calculated in this study are close but consistently higher, with the exception of Thursday's values [14], [15]. This pattern follows logically, since drivers opting for HOT lanes would naturally have higher values of travel time savings, compared to the average values provided by MnDOT and USDOT. Improvements in the parameter fitting were seen when categorizing results by the day of the week. The values of  $\gamma$  show little variation between days and were, therefore, fixed at a constant value of -1.71781 for our model. Cases of severe congestion did occur in the sampled time, due to heavy



snow. These days were not included in the analysis, as the congestion was significant enough to show degradation of the speed in the HOT lane equal to that of the GPL lanes.

TABLE I  
MEAN VALUES OF FITTED DRIVER BEHAVIOR PARAMETERS BY DAY OF THE WEEK

	Mon.	Tues.	Wed.	Thur.	Fri.	Average
$\alpha$	-0.2879	-0.3409	-0.3953	-0.3710	-0.3026	-0.3340
$\beta$	0.3306	0.4182	0.3199	0.2936	0.3901	0.3550
$VOT$	1.148	1.227	0.8093	0.7915	1.289	1.063

### C. PD Gains

Assuming that the inverse driver behavior model perfectly cancels out the nonlinearity, the underlying relationship between  $\rho_{ref}$  and  $\rho$  is a linear dynamic system of first-order. Therefore, one can use pole-placement methods to determine the PD gains. The PD gains were chosen such that there was no overshoot and settling time was 2.8 minutes. This in turn implied that the closed-loop transfer function has a damping ratio 1.1 and natural frequency of 1.25rad. This led to a selection of PD gains  $K_d = 0.45$  and  $K_p = 1.75$ . The feed forward gain,  $K_{ff} = 0.4$  was chosen to corresponded the equilibrium model.

### D. Target Density Selection

With Section IV-A, IV-B, and IV-C determining the traffic model parameters, the behavioral model parameters, and the PD control gains, respectively, the only quantity that remains to be determined is the desired traffic density, which is a reference signal into the whole closed-loop. Based on the fundamental diagram, for a given input flow and desired HOT minimum speed, there are a variety of HOT and GPL densities that result. For a specific choice of those two variables, the overall output flow is maximized, and that operating point is what is referred to as the sweet spot for our simulations. At this point, the speed decrease to GPL is minimal, the guarantees to the HOT users are satisfied, and the system benefit is achieved with the maximization of overall flow.

## V. RESULTS

The flow dynamics together with the driver behavior model are specified in Section II-A, II-B and in II-C, respectively. The parameters of this model are given by  $\tau$  and  $\alpha$ ,  $\beta$ , and  $\gamma$ . The dynamic toll price strategy is specified in Section III, and the parameters of this strategy are given in Section IV. We now describe the results obtained using our dynamic toll pricing controller in this section.

### A. Model Validation

Our first step in validating the price controller proposed Section IV is the validation of the socio-technical model described in Section II. As the MnPASS system has data available regarding  $P_{HOT}$ ,  $q_{in,HOT}$ ,  $q_{out,HOT}$ , and speeds, with their price controller determining the HOT lane price, we use their data for this validation (see Fig. 8).

The MnPASS price control algorithm is shown in Fig. 1. Because the MnPASS toll price is determined based on both the current density and the change in density over time, a PD controller was chosen, without a feed-forward component or inverse driver behavior model, to recreate the MnPASS pricing system within our simulation environment. A variety of PD gains were tested in order to obtain results similar to the actual, measured data. The best match in results occurred when  $K_p = 0.25$  and  $K_d = 1.3$ . The low proportional gain results from the lack of a target density in the MnPASS pricing scheme. The resulting density and total flow obtained from MnPASS on Oct. 6, 2014 are shown in Figure 9, and compared with the estimated quantities using our socio-technical model given by Eqs. (3)-(13). Similar results were obtained for a range of dates in 2014. This shows that our driver behavior model, traffic flow model, and equilibrium model is a reasonable approximation of the actual traffic flow.

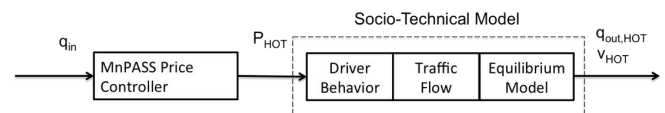

Fig. 8. The MnPASS pricing controller was placed alongside our socio-technical model to validate the use of our system model.

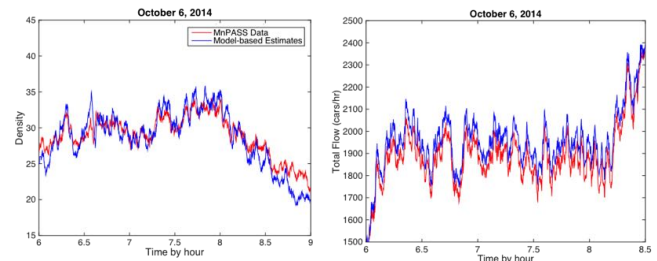

Fig. 9. The similarity of the density and speed plots of our simulated system (blue) and the actual MnPASS system (red) validate the use of our model-based system.

### B. Results of our Model-based Pricing Controller

We now use the socio-technical model in Section II, with parameters  $\alpha = -0.3026$ ,  $\beta = 0.3901$ ,  $\rho_{critical} = 25$ ,  $\rho_{jam} = 80$ ,  $v_{free-flow} = 65$ , and  $v_{jam} = 5$ . With the inverse behavior model as in eq. (11), and the control gains chosen as  $K_{ff} = 0.4$ ,  $K_d = 0.45$  and  $K_p = 1.75$  and a desired density of  $\rho = 30$ , the overall traffic-flow with the price controller was simulated. The resulting density is shown in Figure 9a. These results are also compared with the MnPASS controller, whose response was simulated using the same socio-technical model and the MnPASS pricing strategy described in Section V-A. It can be seen that the responses are comparable. In order to generate a more aggressive strategy that quickly returns the HOT densities to the desired value, the PD gains were changed to such that there was again no overshoot and the settling time was 1.5 minutes. The resulting responses are shown in Figure

10b that illustrate the significant improvement of our pricing controller in comparison with that of MnPASS.

To better illustrate the performance of our controller, an input flow that introduced congestion in the middle of the operating period was chosen. The corresponding densities as well as price profiles, speeds, and total flows, both for our controller and the MnPASS controller, are shown in Figure 11. These plots especially show the significant improvement in the increase of total flow in comparison to MnPASS. While the prices are larger, we note that the price cap of \$8 set by MnPASS was not violated anywhere. All of these plots corresponded to a desired density of 30 cars/mi.

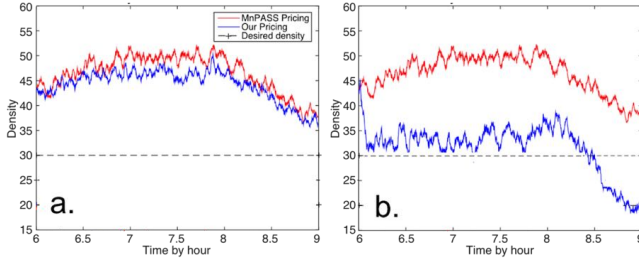

Fig. 10. PID gains were chosen in 10a to match the behavior of MnPASS and validate our system model. The gains were changed for the simulation run in 10b to yield a more aggressive pricing scheme that was successful in preventing congestion in the HOT lane.

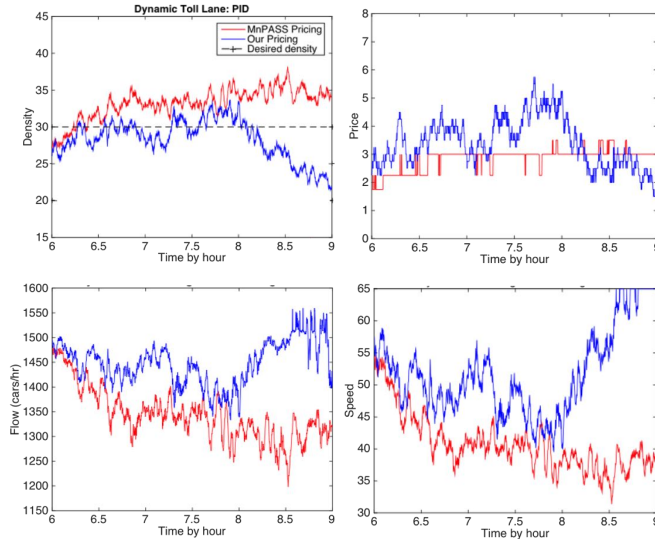

Fig. 11. High input flow is introduced in the middle of the operating period to test the systems' ability to prevent congestion. The model-based system is successful in keeping the HOT density low compared to MnPASS.

It is clear that instances of congestion still occur with the MnPASS pricing model, as their density climbs past the threshold between free-flow and congestion in 4 of the 5 graphs. Our pricing controller is targeting a density value below the critical density, so that the traffic flow remains in the linear, free-flow region. As a result, as is illustrated in Fig. 11, the corresponding densities remain below the critical density, despite the large input flow to the system.

Looking at the graphs of the toll prices, it is clear that the more aggressive PD gains are the key factor in preventing congestion. In addition, another strength of this pricing strategy is the ability to minimize flow and speed fluctuations, which is desirable for a better driver experience.

### C. Effect of Inverse Driver Behavior Component

Simulations were run without the inverse driver behavior component in the pricing scheme. Theoretically, this has the effect of introducing an unknown gain into the system. The results are shown in Figure 12, with and without the inverse function, and it can be seen that in the latter, the tracking error in density is much poorer when compared to the former.

We also evaluated the effect of an incorrect inverse driver behavior model. For this purpose, we replaced the parameters  $\alpha$  and  $\beta$  by  $\lambda_\alpha\alpha$  and  $\lambda_\beta\beta$  respectively, with  $\lambda_\alpha = 5$  and  $\lambda_\beta = 2$ . The resulting density response is shown in Figure 13 (in red), and compared with the correct parameter values, i.e.  $\lambda_\alpha = 1$  and  $\lambda_\beta = 1$  (in blue). As these plots show, the pricing control performance is somewhat insensitive to the inverse driver behavior parameters. But as Figure 12 shows, the pricing control performance is sensitive to the presence of the inverse nonlinearity itself.

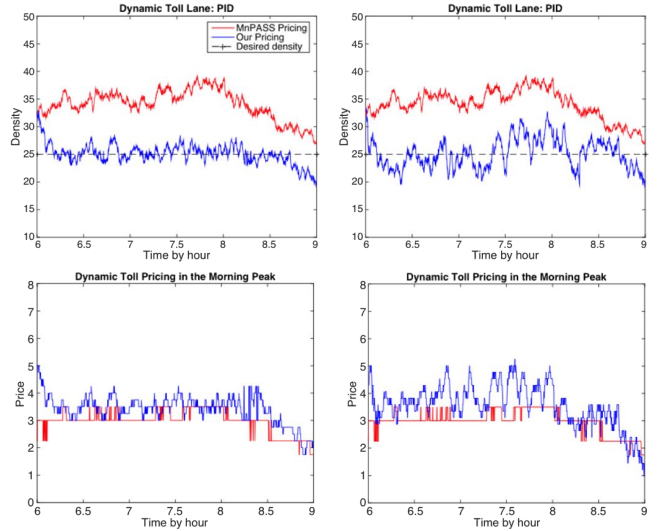

Fig. 12. While the system without the inverse driver behavior pricing component (right) is able to keep the system from experience congestion, it fluctuates about the target density much more than the system with the inverse behavior component (left).

### D. Comparison with Prior Research

As mentioned in the introduction, ref. [12] has examined the MnPass strategy with changes in their pricing strategy (shown in Table 1) in order to better understand driver elasticity and decision-making. In particular, four different pricing strategies, consisting of proportional control with exponential weighting on the HOT density and proportional control on the density difference with no weight, weighting on the HOT density, and weighting on the GPL density. Of these, the first one was

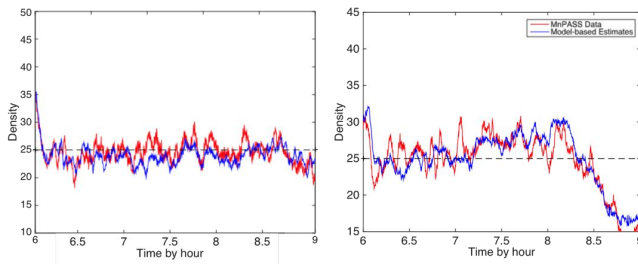

Fig. 13. System performance with the incorrect driver behavior parameters,  $\alpha$  and  $\beta$ .

implemented in our simulation studies and compared with our proposed controller in Fig. 14.

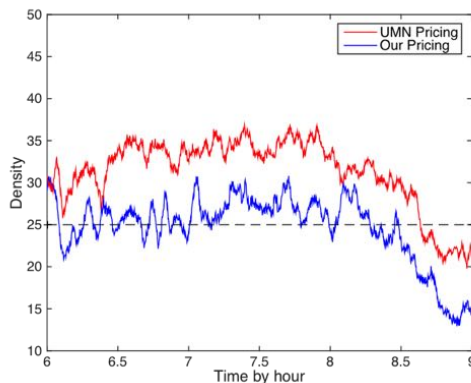

Fig. 14. Comparison between our controller and the first alternative pricing strategy from UMN.

### E. Revenue Effects

An important component in any new toll pricing system is effect it will have on revenue generation. Because the proposed pricing strategy can be implemented within the existing infrastructure without any modifications to the infrastructure, any differences in revenue will result from the changes in toll prices and toll lane users. The revenue generation was calculated based on the number of HOT users and the toll price at the time of entrance into the road segment. Comparisons between the existing MnPASS system and our pricing system indicate that the proposed system results in the same or higher revenues for all cases. This could certainly change if the controller gains are chosen to be less aggressive, but again, that is a design choice that can be easily altered.

## VI. CONCLUSION

A real-time dynamic toll pricing scheme has the potential to reduce traffic congestion without the significant infrastructure costs that other alternatives, such as road expansion and public transportation development, require. In this paper, a dynamic toll-pricing strategy was proposed based on a socio-technical model that includes driver behavior model and traffic flow.

Based on measured values from the MnPASS network, the socio-technical model was validated. The toll-pricing strategy consisted of a nonlinearity that served as the inverse driver behavior model, and a simple PD controller. Using data from the actual traffic inflow from MnPASS and simulations of our socio-technical model and the dynamic pricing controller, the results of our toll pricing controller were obtained, and shown to successfully reduce traffic congestion more effectively than the current MnPASS pricing scheme. The overall approach of using dynamic toll pricing for management of highway traffic can be viewed as one of the important building blocks of a Smart City [16].

Several areas of study remain in the proposed line of inquiry. Extensions to road segments with more lanes, merges, and traffic flow in connected segments, will all require more careful modeling, analysis, and synthesis tools. The role of more complex behavioral models as well as nonlinear and distributed traffic flow models need to be carefully examined as well.

## ACKNOWLEDGMENT

We gratefully acknowledge Mike Solomonson and Brian Kary at MnDOT for several useful discussions and for providing us with the MnPASS data.

## REFERENCES

- [1] IBM. (2014). Building a smarter transportation management network. Retrieved August 20, 2015, from <http://public.dhe.ibm.com/common/ssi/ecm/lb/en/lbw03019usen/LBW03019USEN.PDF>
- [2] Gyimesi, K., Vincent, C., & Lamba, N. (2011). Frustration Rising: ICM 2011 Commuter Pain Survey.
- [3] Schrank, S., Eisele, B., & Lomax, T. (2012). 2012 Urban Mobility Report.
- [4] Cambridge Systematics, I. (2006). I-394 MnPASS Technical Evaluation.
- [5] Washington State Department of Transportation. (2012). SR 520 Toll Operations and Traffic Performance Summary Report 2012.
- [6] I-85 Toll Rate Pricing. (n.d.). Retrieved August 20, 2015, from <http://www.peachpass.com/peach-pass-toll-facilities/i-85-toll-rate-pricing>
- [7] Metro ExpressLanes. (n.d.). Retrieved August 20, 2015, from <https://www.metroexpresslanes.net/en/home/index.shtml>
- [8] 495 — 95 Express Lanes - Pricing. (n.d.). Retrieved August 20, 2015, from <https://www.expresslanes.com/pricing>
- [9] Ben-Akiva, M., & Bierlaire, M. (1999). Discrete Choice Methods and their Applications to Short Term Travel Decisions. Handbook of Transportation Science, (1985).
- [10] Lighthill, M. J., & Whitham, G. B. (1955). On Kinematic Waves. II. A Theory of Traffic Flow on Long Crowded Roads. Proceedings of the Royal Society A: Mathematical, Physical and Engineering Sciences.
- [11] Yin, Y., & Lou, Y. (2009). Dynamic Tolling Strategies for Managed Lanes. Journal of Transportation Engineering.
- [12] Janson, M., & Levinson, D. (2014). HOT or not driver elasticity to price on the MnPASS HOT lanes. Research in Transportation Economics, 44(1), 217-232.
- [13] Zhang, G., Ma, X., & Wang, Y. (2014). Self-adaptive tolling strategy for enhanced high-occupancy toll lane operations. IEEE Transactions on Intelligent Transportation Systems, 15(1), 306-317.
- [14] USDOT VOT Guidance 2014. (n.d.). Retrieved August 20, 2015, from [https://www.transportation.gov/sites/dot.gov/files/docs/USDOT\\_VOT\\_Guidance\\_2014.pdf](https://www.transportation.gov/sites/dot.gov/files/docs/USDOT_VOT_Guidance_2014.pdf)
- [15] Benefit-Cost Analysis for Transportation Projects. (n.d.). Retrieved August 20, 2015, from [http://www.dot.state.mn.us/planning/program/appendix\\_a.html](http://www.dot.state.mn.us/planning/program/appendix_a.html)
- [16] R. Sengupta, A.M. Annaswamy, S. Amin, S. Moura, & V. Bulusu, "Smart Cities and Control," IEEE Control Systems Magazine (to appear), 2015.